

REV.	DESCRIPTION	DATE

THESE DRAWINGS ARE THE PROPERTY OF *Thermaltake CO.,LTD.* AND CONTAINS CONFIDENTIAL AND TRADE SECRET INFORMATION AND SHALL NOT BE REPRODUCED, COPIED OR USED IN ANY MANNER WITHOUT THE PRIOR WRITER CONSENT OF *Thermaltake CO.,LTD.*

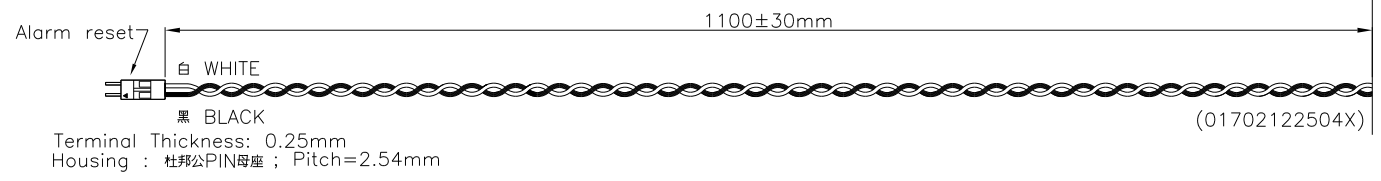
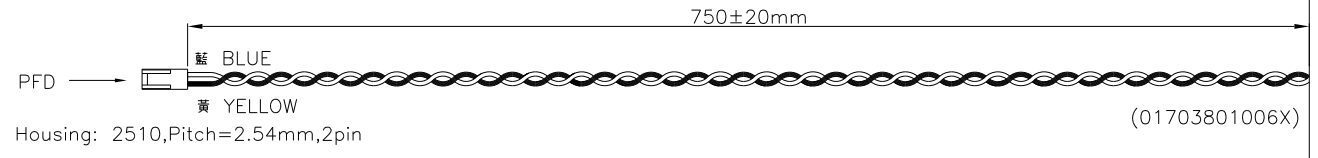
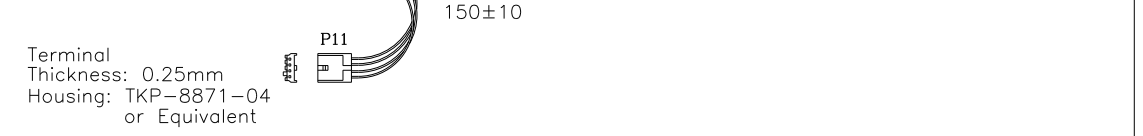
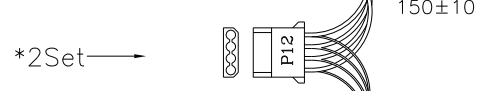
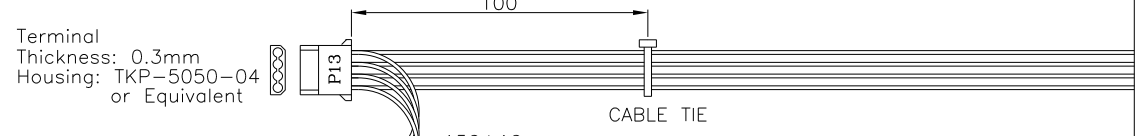
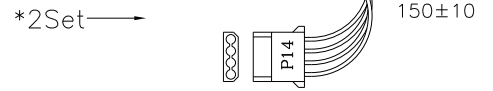
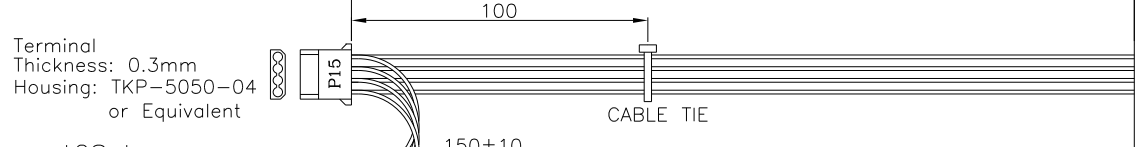
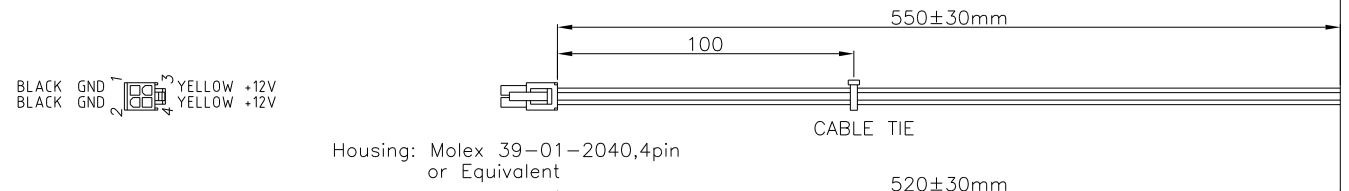
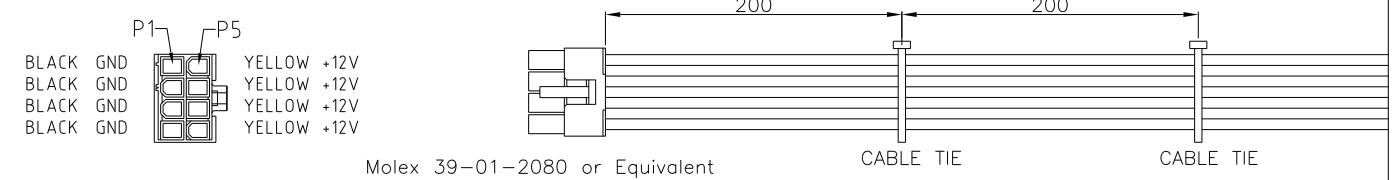
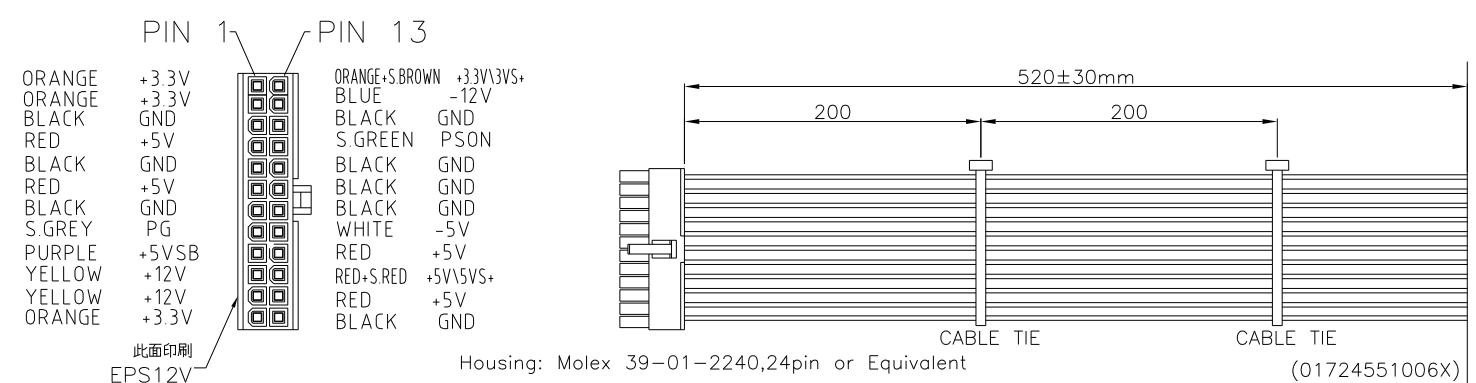

Note:
1.須符合 S-TT-001 標準

MATERIAL	
FINISH	
COLOR	
TOLERANCES UNLESS NOTED	
0.0 ~ 5	± 0.1
5.0 ~ 20	± 0.2
20.0 ~ 50	± 0.3
50.0 ~ 200	± 0.4
200.0 ~	± 0.5
ANGLE	± 1°

REV.	T1
WEIGHT	
SCALE	1:1
UNIT	mm
THIRD ANGLE PROJECTION	

ITEM	PART NO.	DESCRIPTION	QTY
 Thermaltake Technology Co., Ltd			
DRAWING NAME		TP-2UR460L1E_Cable	
PART NO.		WSPR0017_Cable	
DATE	APP.	CHK.	DRAW
2008/07/08			TIN