

SPECIFICATION

Model: TP-2UR460L1E

**N+1 Hot-Swappable
Redundant Power Supply
With Active PFC
2U 460W+460W**

(P/N of TT:WSPS0017)

Rev:	Description	Author	Date
01	Initial Engineering Specification for TT	Tien	5/21/2008

Sales	Design			Product Verification	
	Mechanical	Electrical	Approval	Safety	Approval



	Subject: TP-2UR460L1E 460W+460W Redundant Power Supply	Description: Electrical Specification
	曜越科技股份有限公司 Thermaltake Technology Co., Ltd	Document No.: ES-15-2463-4

TABLE OF CONTENTS

1. General.....	4
2. AC Input Characteristics.....	4
2.1 AC INPUT VOLTAGE, FREQUENCY AND CURRENT (RATING: 100V-240VAC, 47-63Hz, 8-4A).....	4
2.2 AC INRUSH CURRENT.....	4
2.3 INPUT POWER FACTOR CORRECTION (ACTIVE PFC).....	4
2.4 INPUT CURRENT HARMONICS.....	4
2.5 AC LINE DROPOUT.....	4
2.6 AC LINE SLOW TRANSIENTS.....	4
2.7 AC SURGE VOLTAGES.....	5
2.8 SURGE IMMUNITY, IEC61000-4-5.....	5
2.9 ELECTRICAL FAST TRANSIENT / BURST, IEC61000-4-4.....	5
2.10 ELECTRICAL DISCHARGE, IEC61000-4-2.....	5
2.11 RADIATED IMMUNITY, IEC61000-4-3.....	6
3. DC Output Specification.....	6
3.1 OUTPUT CURRENT / LOADING.....	6
3.2 DC VOLTAGE REGULATION, RIPPLE AND NOISE.....	6
3.3 DYNAMIC LOADING.....	7
3.4 CAPACITIVE LOADING.....	7
3.5 TIMING REQUIREMENTS.....	7
3.6 POWER GOOD SIGNAL: PWOK.....	9
3.7 REMOTE ON/OFF CONTROL: PSON#.....	10
3.8 OVERSHOOT AT TURN-ON /TURN-OFF.....	10
3.9 EFFICIENCY.....	10
3.10 +5VSB (STANDBY).....	10
4. Protection.....	10
4.1 OVER CURRENT PROTECTION.....	10
4.2 OVER VOLTAGE PROTECTION.....	11
4.3 SHORT CIRCUIT PROTECTION.....	11
4.4 NO LOAD OPERATION.....	11
5. Environmental Requirements.....	11
5.1 TEMPERATURE.....	11
5.2 HUMIDITY.....	11
5.3 ALTITUDE.....	11
5.4 MECHANICAL SHOCK.....	11
5.5 VIBRATION (OPERATING AND NON-OPERATING).....	12
5.6 ACOUSTIC NOISE.....	12
6. Agency Requirements.....	12
6.1 SAFETY CERTIFICATION.....	12
6.2 INPUT LEAKAGE CURRENT.....	12
6.3 PRODUCTION LINE TESTING.....	12
6.4 HI-POT TESTING.....	13
6.5 GROUND CONTINUITY TESTING.....	13
7. Redundant Power Supply Function:.....	13
7.1 REDUNDANCY.....	13
7.2 HOT SWAP REQUIREMENTS.....	13
7.3 LED INDICATORS.....	13
8. Reliability.....	14
8.1 MEAN TIME BETWEEN FAILURES (MTBF).....	14

 <p>Thermaltake <i>COOL ALL YOUR LIFE</i></p>	<p>Subject: TP-2UR460L1E 460W+460W Redundant Power Supply</p>	<p>Description: Electrical Specification</p>
<p>曜越科技股份有限公司 Thermaltake Technology Co., Ltd</p>		<p>Document No.: ES-15-2463-4</p>

8.2 WARRANTY 14

9. Connections..... 14

 9.1 AC INPUT CONNECTOR 14

 9.2 DC WIRE HARNESS AND CONNECTOR REQUIREMENTS..... 14

10. Physical Characteristics Size 15

 10.1 WEIGHT: 4.0KG..... 15

 10.2 DIMENSION: 102.2MM(W) X 84.2MM(H) X 300.0MM(D)..... 15

 10.3 MOUNTING REQUIREMENTS: SEE ATTACHMENT 15

	Subject: TP-2UR460L1E 460W+460W	Description: Electrical Specification
曜越科技股份有限公司 Thermaltake Technology Co., Ltd	Redundant Power Supply	Document No.: ES-15-2463-4

1. General

This specification describes the electrical characteristics, functional and physical of a 460W+460W =460Watts redundant power supply with Active PFC (Power Factor Correction) and hot-swappable capabilities.

2. AC Input Characteristics

2.1 AC Input Voltage, Frequency and Current (Rating: 100V-240Vac, 47-63Hz, 8-4A)

The power supply must operate within all specified limits over the input voltage range in Table 1.

Harmonics distortion of up to 10% THD must not cause the power supply to go out of specified limits.

Parameter	Minimum	Rated	Maximum	Max. Current
Voltage (115V)	90 Vac	100-127Vac	132 Vac	8 A
Voltage (230V)	180 Vac	200-240Vac	264Vac	4 A
Frequency	47 Hz	50 / 60 Hz	63 Hz	

Table 1 – AC Input Voltage , Frequency and Current

2.2 AC Inrush Current

AC line inrush current shall not damage any component nor cause the AC line fuse to blow under any DC conditions and with any specified AC line input voltage and frequency. Repetitive On/Off cycling of the AC input voltage shall not damage the power supply.

2.3 Input Power Factor Correction (Active PFC)

The power factor at full load shall be ≥ 0.95 at nominal input voltage.

2.4 Input Current Harmonics

When the power supply is operated in 90-264Vac of Sec. 2.1, the input harmonic current drawn on the power line shall not exceed the limits set by EN61000-3-2 class “D” standards. The power supply shall incorporate universal power input with active power factor correction.

2.5 AC Line Dropout

An AC line dropout of 17mS or less shall not cause any tripping of control signals or protection circuits. If the AC dropout lasts longer than 17mS the power supply should recover and meet all turn on requirements. The power supply shall meet the regulation requirement over all rated AC voltages, frequencies, and output loading conditions. Any dropout of the AC line shall not cause damage to the power supply. An AC line dropout is defined as a drop in AC line to 0VAC at any phase of the AC line for any length of time.

2.6 AC Line Slow Transients

AC line slow transient conditions shall be defined as “sag” and “surge” conditions. Sag conditions (also referred To as “brownout” conditions) will be defined as the AC line voltage dropping below nominal. Surge Conditions will be defined as the AC line voltage rising above nominal voltage.

The power supply shall meet the regulation requirements under the following AC line sag and surge conditions.

 Thermaltake Technology Co., Ltd	Subject: TP-2UR460L1E 460W+460W Redundant Power Supply	Description: Electrical Specification
		Document No.: ES-15-2463-4

Duration	Sag	Operating AC Voltage	Line Frequency	Performance Criteria
Continuous	10%	Nominal AC Input ranges	50/60 Hz	No loss of function or performance
0-1 AC cycle	100%	Nominal AC Input ranges	50/60 Hz	No loss of function or performance
> 1 AC cycle	>10% (110V) >30% (220V)	Nominal AC Input ranges	50/60 Hz	Loss of function Acceptable, self recoverable

Table 3 – AC Line Sag Transient Performance

Duration	Surge	Operating AC Voltage	Line Frequency	Performance Criteria
Continuous	10%	Nominal AC Voltage	50/60 Hz	No loss of function or performance
0 - ½ AC cycle	30%	Mid-point of Nominal AC Voltage	50/60 Hz	No loss of function or performance

Table 4 – AC Line Surge Transient Performance

2.7 AC Surge Voltages

The power supply shall be tested and be compliant with the requirements of IEC61000-4-5 Level 3 criteria for surge withstand capability, with the following conditions and exceptions. The test equipment and calibrated waveforms shall comply with the requirements of IEC61000-4-5 for open circuit voltage and short circuit current.

- These input transients must not cause any out of regulation conditions, such as overshoot and undershoot, nor must it cause any nuisance trips of the power supply protection circuits.
- The surge-withstand test must not produce damage to the power supply.
- The power supply must meet surge-withstand test condition under maximum and minimum DC output load conditions.

2.8 Surge Immunity, IEC61000-4-5

The peak value of the unidirectional surge waveform shall be 2KV for common mode and 1KV for differential mode of transient surge injection. No unsafe operation or no user noticeable degradation is allowed under any condition. Automatic or manual recovery is allowed for other conditions.

2.9 Electrical Fast Transient / Burst, IEC61000-4-4

No unsafe operation allowed under any condition. No user noticeable performance degradation up to 1KV is allowed. Automatic or manual recovery is allowed for other conditions.

2.10 Electrical Discharge, IEC61000-4-2

In addition to IEC61000-4-2, the following ESD tests should be conducted. Each surface area of the unit under test should be subjected to twenty (20) successive static discharges, at each of the follow voltages: 2KV, 3KV, 4KV, 5KV, 6KV, 8KV.

All power supply outputs shall continue to operate within the parameters of this specification, without glitches or interruption, while the power is operating as defined and subjected to 2kV through 10kV ESD pulses. The direct ESD event shall not cause any out of regulation conditions such as overshoot or undershoot. The power supply shall withstand these shocks without nuisance trips of the Over-Voltage Protection, Over-Current Protection, or the remote +5VDC, +12VDC shutdown circuitry.

 Thermaltake <small>COOL ALL YOUR LIFE</small>	Subject:	Description:
	曜越科技股份有限公司 Thermaltake Technology Co., Ltd	TP-2UR460L1E 460W+460W Redundant Power Supply

2.11 Radiated Immunity, IEC61000-4-3

Frequency	Electric Field Strength
27 MHz to 500 MHz, un-modulated	3 V/m

3. DC Output Specification

3.1 Output Current / Loading

The following tables define two power and current rating. The power supply shall meet both static and dynamic voltage regulation requirements for minimum load condition.

Output Voltage	+5V	+3.3V	+12V	-12V	+5VSB
Max. Load	30A	28A	35A	0.8A	2A
Min. Load	3A	1A	1A	0A	0A

Table 5 – Load Range 1:

Note 1: The +5 & +3.3 Volt total output shall not exceed 200 W.

Note 2: Total +12V1,+12V2 and +12V3 total output shall not exceed 35A.

Note 3: Peak +12V DC output power should not exceed 38A peak for a minimum of 12 seconds.

Note 4: The +5, +3.3 & +12V total output shall not exceed 440W.

Note 5: Maximum continues total DC output power should not exceed 460W.

Table 5 – Load Range 1

(N/C)

3.2 DC Voltage Regulation, Ripple and Noise

The power supply output voltages must stay within the following voltage limits when operating at steady state and dynamic loading conditions. All outputs are measured with reference to the return remote sense (ReturnS) signal. The +5V, +12V, -12V and +5BSB outputs are measure at the power supply connectors' references to ReturnS. The +5V and +3.3V is measured at its remote sense signal (+5VS+, +3.3VS+) located at the signal connector.

Output Voltage	+5V	+3.3V	+12V1	-12V	+5VSB
Load Reg.	+/-5%	+/-5%	+/-5%	+/-5%	+/-5%
Line Reg.	±1%	±1%	±1%	±1%	±1%
Ripple & Noise	50mV	50mV	120mV	120mV	50mV

Table 7 – Regulation, ripple and noise

Ripple and noise shall be measured using the following methods:

- Measurements made differentially to eliminate common-mode noise
- Ground lead length of oscilloscope probe shall be ≤ 0.25 inch.
- Measurements made where the cable connectors attach to the load.
- Outputs bypassed at the point of measurement with a parallel combination of 10uF tantalum capacitor in parallel with a 0.1uF ceramic capacitors.
- Oscilloscope bandwidth of 0 Hz to 20MHz.

 曜越科技股份有限公司 Thermaltake Technology Co., Ltd	Subject: TP-2UR460L1E 460W+460W Redundant Power Supply	Description: Electrical Specification
		Document No.: ES-15-2463-4

f) Measurements measured at locations where remote sense wires are connected.

g) Regulation tolerance shall include temperature change, warm up drift and dynamic load

3.3 Dynamic Loading

The output voltages shall remain within the limits specified in Table 7 for the step loading and within the limits specified in Table 8 for the capacitive loading. The load transient repetition rate shall be tested between 50Hz and 5kHz at duty cycle ranging from 10%-90%. The load transient repetition rate is only a test specification. The Δ step load may occur anywhere within the MIN load to the MAX load shown in Table 5 and Table 6.

Output	Δ Step Load Size		Load Slew Rate	Capacitive Load
	Δ Step Load	Step Load		
+5V	30%	1.0 to 10.0A & 18.0 to 27A	0.5 A/uS	5600 uF
+3.3V	30%	1.0 to 10.0A & 18.0 to 26A	0.5 A/uS	3300 uF
+12V1,+12V2,+12V3	50%	1.5 to 8A & 6.0 to 13A	0.5 A/uS	3000 uF
+5VSB	30%	0.1 to 0.7A & 1.4 to 2A	0.5 A/uS	100 uF

Table 8 – Transient Load requirements

3.4 Capacitive Loading

The power supply shall be stable and meet all requirements, except dynamic loading requirements, with the following capacitive loading ranges.

Output	MIN	MAX	Units
+5V	400	4,700	uF
+3.3V	250	6,800	uF
+12V	500	11,000	uF
-12V	1	350	uF
+5VSB	20	350	uF

Table 9 – Capacitive Loading Conditions

3.5 Timing Requirements

These are the timing requirements for the power assembly operation. The output voltages must rise from 10% to within regulation limits (T_{vout_rise}) within 5 to 70mS. The +5V, +3.3V and +12V output voltages should start to rise at about the same time. All outputs must rise monotonically. The +5V output needs to be greater than the +3.3V output during any point of the voltage rise. The +5V output must never be greater than the +3.3V output by more than 2.25V. Each output voltage shall reach regulation within 50 mS (T_{vout_on}) of each other during turn on of the power supply. Each output voltage shall fall out of regulation within 400 mS (T_{vout_off}) of each other during turn off. Figure 1 and figure 2 show the turn On and turn Off timing requirement. In Figure 2, the timing is shown with both AC and PSON# controlling the On/Off of the power supply.

 Thermaltake <small>COOL ALL YOUR LIFE</small>	Subject:	Description:
	曜越科技股份有限公司 Thermaltake Technology Co., Ltd	TP-2UR460L1E 460W+460W Redundant Power Supply

Item	Description	MIN	MAX	Units
T _{vout_rise}	Output voltage rise time from each main output.	5	70	mS
T _{vout_on}	All main output must be within regulation of each other within this time.		50	mS
T _{vout_off}	All main output must leave regulation within this time		400	mS

Table 10 – Output Voltage Timing

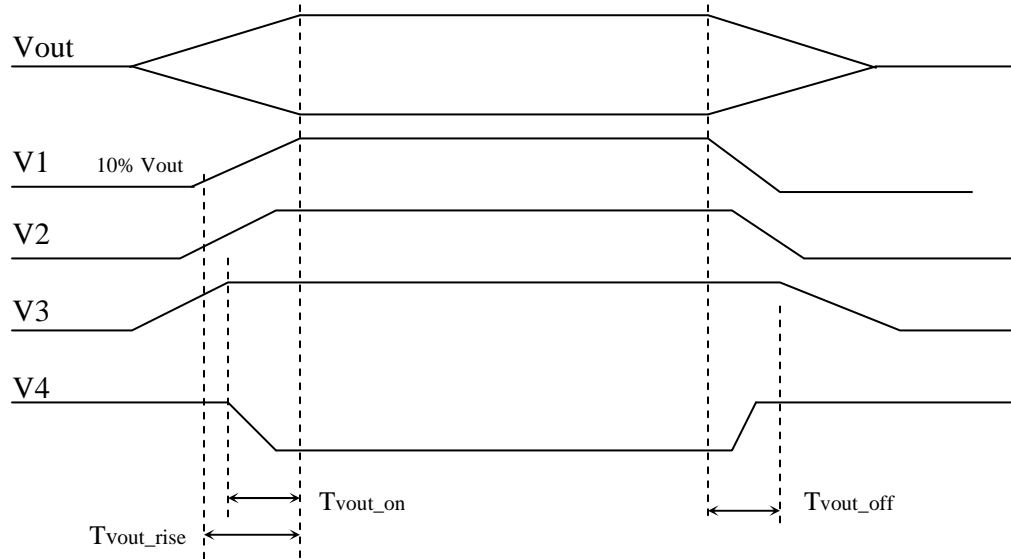

Figure 1: Output Voltage Timing

Item	Description	MIN	MAX	Units
T _{sb_on-delay}	Delay from AC being applied to +5VSB being within regulation.		1500	mS
T _{ac_on-delay}	Delay from AC being applied to all output voltages being within regulation.		2500	mS
T _{vout_holdup}	Time all output voltage stay within regulation after loss of AC	17		mS
T _{pwok_holdup}	Delay from loss of AC deassertion of PWOK.	16		mS
T _{pson_on_delay}	Delay from PSON# active to output voltage within regulation limits.	5	400	mS
T _{pson_pwok}	Delay from PSON# deactive to PWOK being deasserted.		50	mS
T _{pwok_on}	Delay from output voltage within regulation limits to PWOK asserted at turn on.	250	1000	mS
T _{pwok_off}	Delay from PWOK deasserted to output voltages (+5V, +3.3V, +12V, -12V) dropping out of regulation limits.	1		mS
T _{pwok_low}	Duration of PWOK being in the deasserted state during an off/on cycle using AC or the PSON# signal. .	100		mS
T _{sb_vout}	Delay from +5VSB being in regulation to O/Ps being in regulation at AC turn on.	50	1000	mS

 Thermaltake <small>COOL ALL YOUR LIFE</small>	Subject: TP-2UR460L1E 460W+460W Redundant Power Supply	Description: Electrical Specification
		Document No.: ES-15-2463-4
曜越科技股份有限公司 Thermaltake Technology Co., Ltd		

Table 11 – Turn On/Off Timing

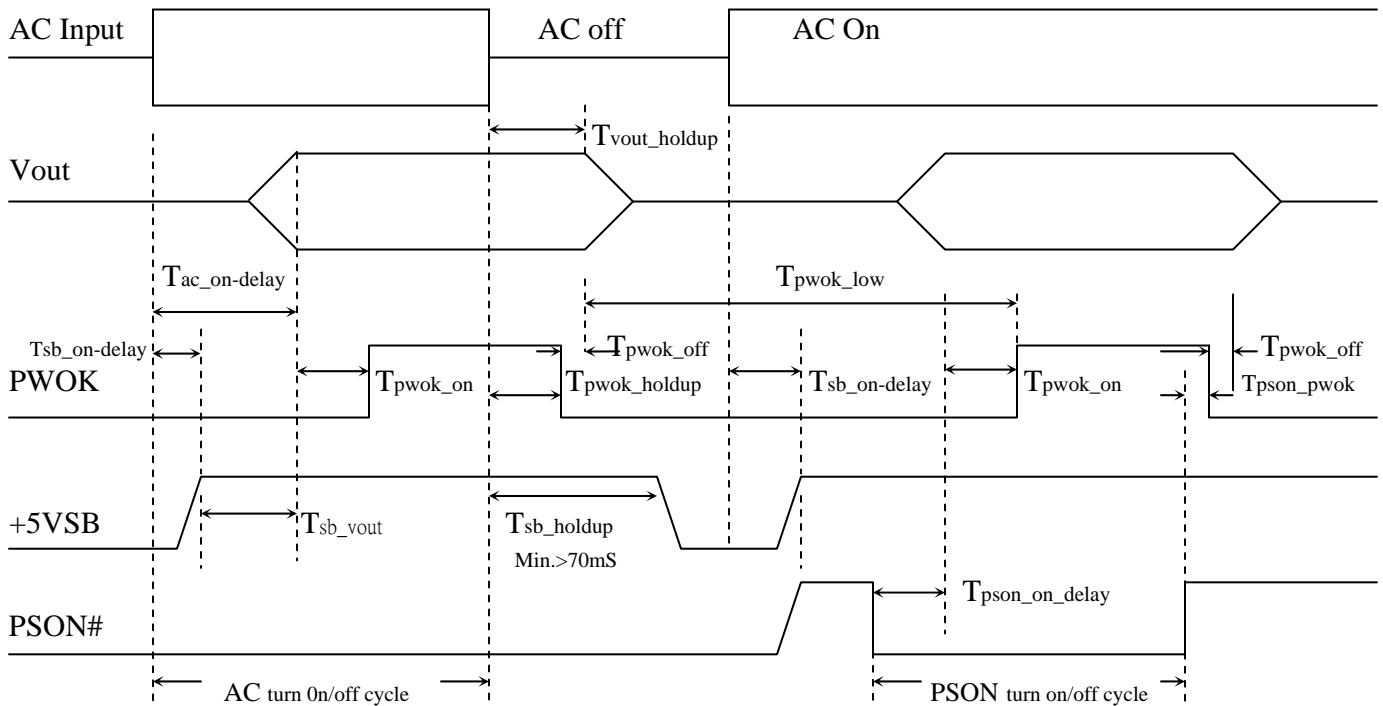



Figure 2: Turn On/Off Timing

3.6 Power Good Signal: PWOK

PSOK is a power OK signal and will be pulled HIGH by the power supply to indicate that all the outputs are within the regulation limits of the power supply. When any output voltage falls below regulation limits or when AC power has been removed for a time sufficiently long so that power supply operation is no longer guaranteed, PWOK will be deasserted to a LOW state. See for a representation of the timing characteristics of PWOK. The start of PWOK delay time shall inhibited as long as any power supply output is in current limit.

Signal Type	Open collector/drain output from power supply. Pull-up to VSB located in power supply.	
PWOK = High	Power OK	
PWOK = Low	Power is Not OK	
	MIN	MAX
Logic level low voltage, Isink = 4mA	0V	0.4V
Logic level high voltage, Isource = 200 μ A	2.0V	5.25V
Sink current, PWOK = Low		4mA
Source current, PWOK = High		2mA
PWOK delay: T_{pwok_on}	100mSec	1000mSec
PWOK rise and fall time		100 μ Sec

 曜越科技股份有限公司 Thermaltake Technology Co., Ltd	Subject: TP-2UR460L1E 460W+460W Redundant Power Supply	Description: Electrical Specification
		Document No.: ES-15-2463-4

PWOK down delay: T _{pwok_off}	2mSec	200mSec
--	-------	---------

Table 12 – PWOK Signal Characteristics

3.7 Remote On/Off Control: PSON#

The PSON# signal is required to remotely turn on/off the power supply. PSON# is an active low signal that turns on the +5V, +3.3V, +12V and –12V power rails. When this signal is not pulled low by the system, or left open, the outputs (except the +5VSB and Vbias) turn off. This signal is pulled to a standby voltage by a pull-up resistor internal to the power supply.

Signal Type	Accepts an open collector/drain input from the system. Pull-up to VSB located in power supply.	
PSON# = Low	Power ON	
PSON# = Open	Power OFF	
	MIN	MAX
Logic level low (Power supply ON)	0V	0.8V
Logic level low (Power supply OFF)	2.4V	5.25V
Source current, V _{pson} = Low		4mA
Power up delay: T _{pson_on_delay}	5mSec	400mSec
PWOK delay: T _{pson_pwok}		50mSec

Table 13 – PWOK Signal Characteristics

3.8 Overshoot at Turn-on /Turn-off

Any output overshoot at turn on shall be less than 10% of the nominal output value. Any overshoot shall recover to within regulation in less than 10ms.

3.9 Efficiency

The minimum power supply system efficiency shall be ≥ 65%, measured at nominal input voltage 115 V or 230 V and full loading.

3.10 +5VSB (Standby)

The +5VSB output is always on (+5V Standby) when AC power is applied and power switch is turned on. The +5VSB line is capable of delivering at a maximum of 2.0A for PC board circuit to operate.

4. Protection

Protection circuits inside the power supply shall cause only the power supply’s main outputs to shutdown. If the power supply latches off due to a protection circuit tripping, either a AC cycle OFF for 15 sec, or PSON# cycle HIGH for 1 sec must be able to restart the power supply.

4.1 Over Current Protection

This power supply shall have current limit to prevent the +5V, +3.3V, and +12V outputs from exceeding the values shown in table 14. The current limit shall not trip under maximum continuous load or peak loading as described in Table 5. The power supply shall latch off if the current exceeds the limit. The latch shall be cleared by toggling the PSON# signal or by cycling the AC power. The power supply shall not be damaged from repeated power cycling in this condition. The –12V and +5VSB outputs shall be shorted circuit protected so that no damage can occur to the power supply.

 Thermaltake <small>COOL ALL YOUR LIFE</small>	Subject:	Description:
	TP-2UR460L1E 460W+460W Redundant Power Supply	Electrical Specification Document No.: ES-15-2463-4
曜越科技股份有限公司 Thermaltake Technology Co., Ltd		

Voltage	Minimum	Maximum	Shutdown Mode
+5V	110%	150%	Latch Off
+3.3V	110%	150%	Latch Off
+12V	110%	150%	Latch Off

Table 14 –Over Current protection

4.2 Over Voltage Protection

The power supply shall shut down in a latch off mode when the output voltage exceeds the over voltage limit shown in Table 4.

Voltage	Minimum	Maximum	Shutdown Mode
+5V	+5.6V	+6.5V	Latch Off
+3.3V	+3.8V	+4.5V	Latch Off
+12V	+13.3V	+14.5V	Latch Off

Table 15 –Over Voltage protection

4.3 Short Circuit Protection

The power supply shall shut down in a latch off mode when the output voltage is short circuit. Age or hazardous conditions shall occur. In such a case, the power supply shall power up and stabilize.

4.4 No Load Operation

When the primary power is applied, with no load on any output voltage, no damage or hazardous conditions shall occur. In such a case, the power supply shall power up and stabilize.

5. Environmental Requirements

5.1 Temperature

Operating Temperature Range:	0°C ~ 50°C (32°F~ 122°F)
Non-Operating Temperature Range:	-40°C ~ 70°C (-40°F~ 158°F)

5.2 Humidity

Operating Humidity Range:	20% ~ 90%RH non-condensing
Non-Operating Humidity Range:	5% ~ 95%RH non-condensing

5.3 Altitude

Operating Altitude Range:	Sea level to 10,000 ft
Non-Operating Altitude Range:	Sea level to 40,000 ft

5.4 Mechanical Shock

The power supply (non-operating) shall not be damaged during a shock of 50G with an 11mS half sin wave, non-operating. The shock to be applied in each of the orthogonal axes.

 曜越科技股份有限公司 Thermaltake Technology Co., Ltd	Subject: TP-2UR460L1E 460W+460W Redundant Power Supply	Description: Electrical Specification
		Document No.: ES-15-2463-4

5.5 Vibration (Operating and Non-operating)

The power supply shall be subjected to a vibration test consisting of a 10 to 300 Hz sweep at a constant acceleration of 2.0g for duration of one (1) hour for each of the perpendicular axes X, Y and Z, 0.1 octave/minute. The output voltages shall remain within specification.

5.6 Acoustic Noise

The power supply shall be tested in accordance with specifications. The overall sound is measured with the noise meter placed 1 meter from the nearest vertical surface of center of fan installed in power supply.

CONDITIONS LIMITS:

115 VAC Input, full load of +5V Acoustic noise is 50 db maximum, 1A of +12V.

6. Agency Requirements

6.1 Safety Certification.

Product Safety:	UL 60950-1, IEC 60950-1 EU Low Voltage Directive(73/23/EEC) (CB) TUV
RFI Emission:	FCC Part15 (Radiated & Conducted Emissions) CISPR 22,3 rd Edition/ EN55022 Class B)
PFC Harmonic:	EN 61000-3-2
Flicker:	EN 61000-3-3
Immunity against:	EN55024: 1998
-Electrostatic discharge:	-IEC 61000-4-2 Min. 4kV contact discharge Min. 8kV air discharge
-Radiated field strength:	-IEC 61000-4-3 Min. 10V/m
-Fast transients:	-IEC 61000-4-4 Min 2kV AC input lines Min 1kV on data lines
-Surge voltage:	-IEC 61000-4-5 Min 2kV common mode Min 1kV differential mode
-RF Conducted	-IEC 61000-4-6
-Voltage Dips and Interruptions	-IEC 61000-4-11

6.2 Input Leakage Current

Input leakage current from line to ground will be less than 3.5mA rms. Measurement will be made at 240 VAC and 60Hz.

6.3 Production Line Testing

100% of the power supply production must have the following test performed. Each power shall be marked indicating the testing was done and passed. Typically this is done by stamping or labeling the power supply with "Hi-pot test OK".

	Subject:	Description:
	曜越科技股份有限公司 Thermaltake Technology Co., Ltd	TP-2UR460L1E 460W+460W Redundant Power Supply

6.4 Hi-Pot Testing

Each power supply must be Hi-pot tested according UL and TUV requirements; Minimum typical testing voltage for Hi-pot testing is 1500Vac or 2121Vdc. However depending on the power supply design the testing voltage May be higher. If higher the power supplies shell be at the higher value.

6.5 Ground Continuity Testing

UL and TUV require that each power supply ground is tested, to ensure there is continuity between the ground inlet of the power supply and the power supply chassis. This can be performed with an ohm meter, or an electronic circuit that lights up and illustrates the ground has continuity.

Based on EN50116, ERG or TUV require that each power supply ground id tested with a 25Amp ground test. Electronic circuit that lights up and illustrates the ground has continuity.

Based on EN50116, ERG or TUV require that each power supply ground id tested with a 25Amp ground test.

7. Redundant Power Supply Function:

7.1 Redundancy

The redundant power supply is N+1=N (550W+550W=550W) function power supply, each one module is redundancy when any one module was failed. To be redundant each item must be in the Hot swap power supply module.

7.2 Hot Swap Requirements

The redundant power supply modules shall be hot swappable. Hot swapping a power supply is the process of inserting and extracting a power supply from an operating. During this process the output voltage shall remain within the limits specified in Table 7 with the capacitive load specified Table 9. The Sub-system shall not exceed the maximum inrush current as specified in section 2.2. The power supply can be hot swapped by the following methods:

- AC connecting separately to each module. Up to two power supplies may be on a single AC power source. Extraction: The AC power will be disconnected from the power supply first and then the power supply is Extracted from the sub-system. This could occur in standby mode or powered on mode. Insertion: The module is inserted into the cage and then AC power will be connected to the power supply module.
- For power modules with AC docking at the same time as DC. Extraction: The module is extracted from the cage and both AC and DC disconnect at the same Time. This could occur in standby or power on mode. No damage or arcing shall occur to the DC or AC contacts which could cause damage. Insertion: The AC and DC connect at the same time as the module is inserted into the cage. No damage to the connector contacts shall occur. The module may power on or come up into standby mode.

Many variations of the above are possible. Supplies need to be compatible with these different variations depending upon the sub-system construction. In general, a failed (off by internal latch or external control) supply may be removed, then replaced with a good power supply(must use the same model) , however, hot swap needs to work with operational as well as failed power supplies. The newly inserted power supply may get turned on by inserting the supply into the system or by system management recognizing an inserted supply and explicitly turning it on.

7.3 LED Indicators

There shall be a single bi-color LED. The GREEN LED shall turn ON to indicate that all the power

	Subject: TP-2UR460L1E 460W+460W	Description: Electrical Specification
曜越科技股份有限公司 Thermaltake Technology Co., Ltd	Redundant Power Supply	Document No.: ES-15-2463-4

outputs are available. The Red LED shall turn ON to indicate that the power supply has failed, shutdown due to over current, or shutdown due to component failure.

The LED(s) shall be visible on the power supply's exterior face. The LED location shall meet ESD requirements. LED shall be securely mounted in such a way that incidental pressure on the LED shall not cause it to become displaced.

8. Reliability

8.1 Mean Time Between failures (MTBF)

The MTBF of the power supply shall be calculated utilizing the Part-Stress Analysis method of MIL217F or Bellcore RPP. The calculated MTBF of the power supply shall be greater than 100,000 hours under the following conditions:

- Full rated load
- 120V AC input
- Ground Benign
- 25°C

8.2 Warranty

FIVE (5) years manufacture's warranty.

Date code indicating the year (200X, X is the first code) and week (2,3 Code is the week) of manufacture.

Technical information in this specification is subject to change without notice.

The revision of specification will be marked on the cover.

9. Connections

9.1 AC Input Connector

The AC input receptacle shall be an IEC 320 type or equivalent. The IEC 320 C receptacle will be considered the mains disconnect.

9.2 DC Wire Harness and Connector Requirements

P1: ATX Motherboard Power Connector

Connector housing: 24- Pin Molex 5557 (No.39-01-2240) or Equivalent

Contact: Molex 5556T (No.44476-1111) or Equivalent

Pin	Signal	Color	Size	Pin	Signal	Color	Size
1	+3.3 VDC	Orange	16 AWG	13	+3.3 VDC 3.3VS+	Orange Brown	16 AWG 22AWG
2	+3.3 VDC	Orange	16 AWG	14	-12 VDC	Blue	18 AWG
3	COM	Black	18 AWG	15	COM	Black	18 AWG
4	+5 VDC	Red	18 AWG	16	PS_ON#	Green	22 AWG
5	COM	Black	18 AWG	17	COM	Black	18 AWG
6	+5 VDC	Red	18 AWG	18	COM	Black	18 AWG
7	COM	Black	18 AWG	19	COM	Black	18 AWG
8	PW_OK	Gray	22 AWG	20	N/C	--	--
9	5VSB	Purple	18 AWG	21	+5 VDC	Red	18 AWG

 <p>Thermaltake COOL ALL YOUR LIFE</p>	<p>Subject: TP-2UR460L1E 460W+460W Redundant Power Supply</p>	<p>Description: Electrical Specification</p>
		<p>Document No.: ES-15-2463-4</p>
<p>曜越科技股份有限公司 Thermaltake Technology Co., Ltd</p>		

10	+12 VDC	Yellow	18 AWG	22	+5 VDC 5VS+	Red Red	18 AWG 22AWG
11	+12 VDC 12VS+	Yellow Yellow	18 AWG 22 AWG	23	+5 VDC	Red	18 AWG
12	+3.3 VDC	Orange	16 AWG	24	COM	Black	18 AWG

P2: Processor Power Connector

Connector housing: 8- Pin Molex 5557 (39-01-2080) or Equivalent

Contact: Molex 5556T (44476-1111) or Equivalent

Pin	Signal	Color	Size	Pin	Signal	Color	Size
1	COM	Black	18 AWG	5	+12 VDC	Yellow	18 AWG
2	COM	Black	18 AWG	6	+12 VDC	Yellow	18 AWG
3	COM	Black	18 AWG	7	+12 VDC	Yellow	18 AWG
4	COM	Black	18 AWG	8	+12 VDC	Yellow	18 AWG

4-Pin HDD / CD-ROM Drive Power Connectors

Connector housing: 4- Pin AMP: 1-480424-0 or Molex 8981-04P or Equivalent

Contact: Amp 61314-1 or Equivalent

Pin	Signal	Color	Size
1	+12 VDC	Yellow	18 AWG
2	COM	Black	18 AWG
3	COM	Black	18 AWG
4	+5 VDC	Red	18 AWG

Small 4-Pin: Floppy Disk Drive Power Connectors

Connector housing: 4- Pin AMP: 171822-4 or Equivalent

Pin	Signal	Color	Size
1	+5 VDC	Red	22 AWG
2	COM	Black	22 AWG
3	COM	Black	22 AWG
4	+12 VDC	Yellow	22 AWG

10. Physical Characteristics Size

10.1 Weight: 4.0Kg

10.2 Dimension: 102.2mm(W) x 84.2mm(H) x 300.0mm(D)

10.3 Mounting Requirements: See attachment

 <p>Thermaltake COOL ALL YOUR LIFE</p>	<p>Subject: TP-2UR460L1E 460W+460W Redundant Power Supply</p>	<p>Description: Electrical Specification</p>
		<p>Document No.: ES-15-2463-4</p>
<p>曜越科技股份有限公司 Thermaltake Technology Co., Ltd</p>		