

REV.	DESCRIPTION	DATE

THESE DRAWINGS ARE THE PROPERTY OF *Thermaltake CO.,LTD* AND CONTAINS CONFIDENTIAL AND TRADE SECRET INFORMATION.AND SHALL NOT BE REPRODUCED, COPIED OR USED IN ANY MANNER WITHOUT THE PRIOR WRITER CONSENT OF *Thermaltake CO.,LTD*.

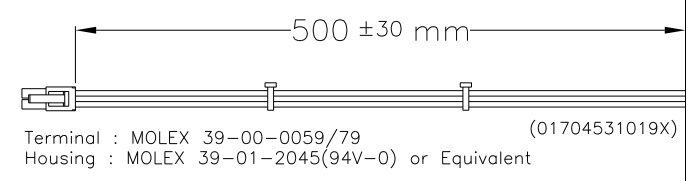

Note: P12~P19
Thickness: 0.3mm
Housing: TKP-5050-04(94V-0) or Equivalent

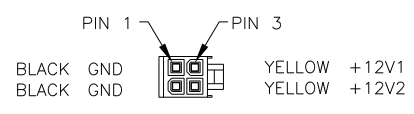
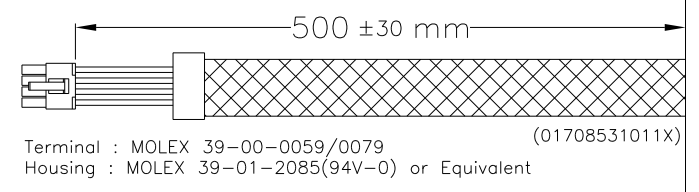
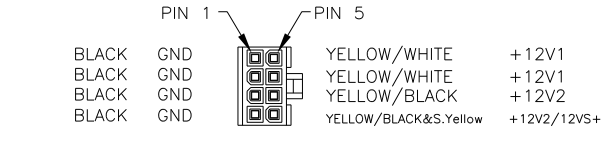
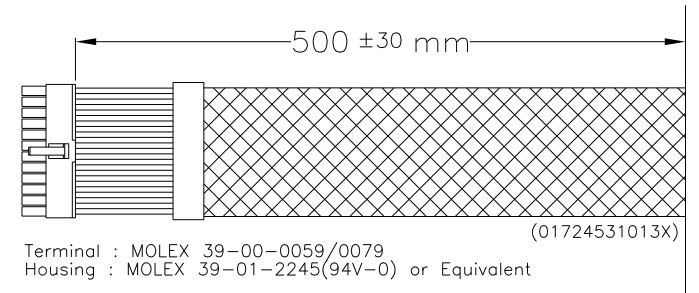
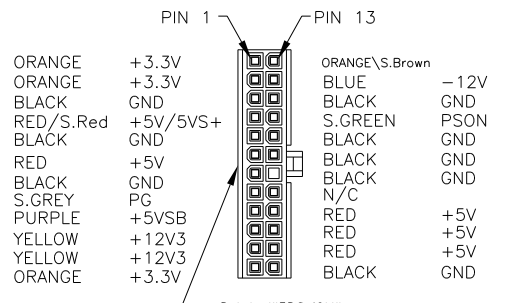
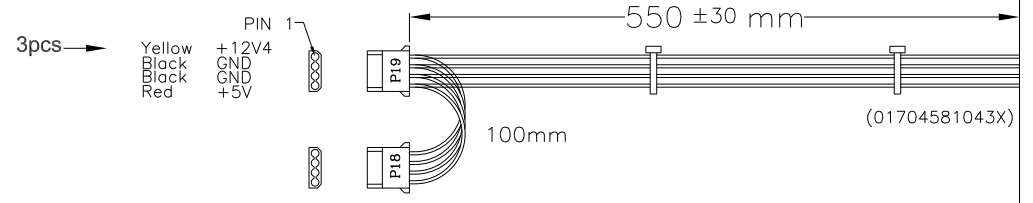

Note : P11
Thickness: 0.25mm
Housing: TKP-8871-04(94V-0) or Equivalent

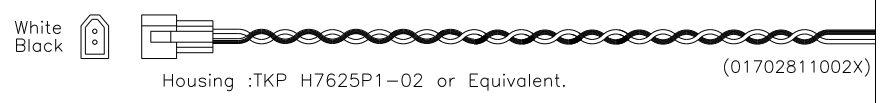
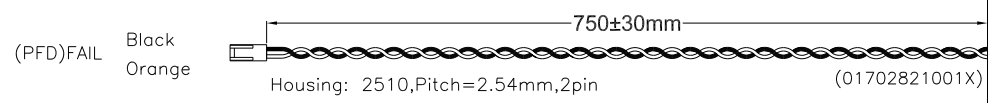
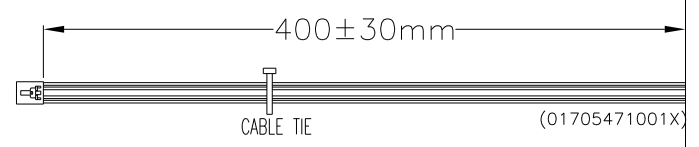
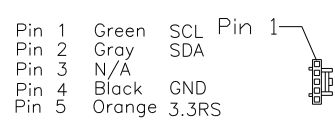
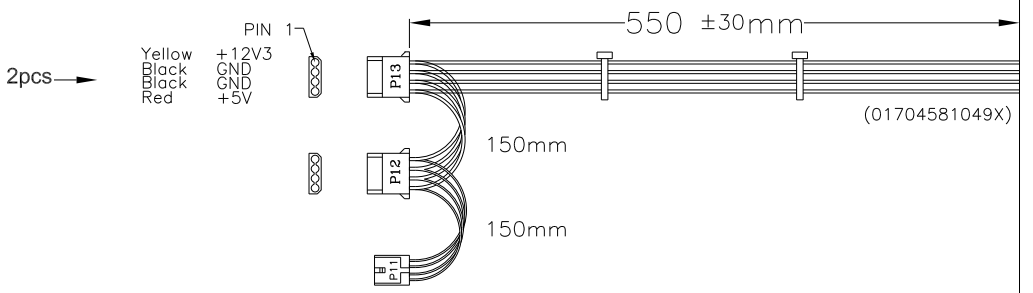

Note:
1.須符合 S-TT-001 標準

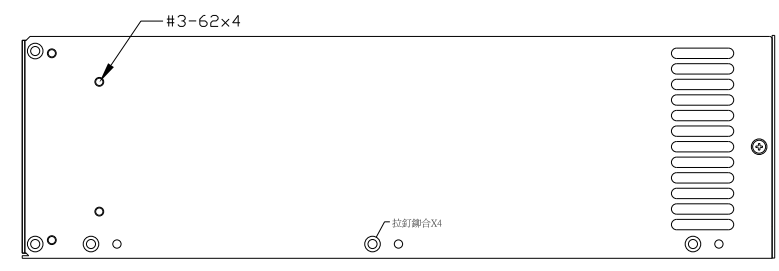
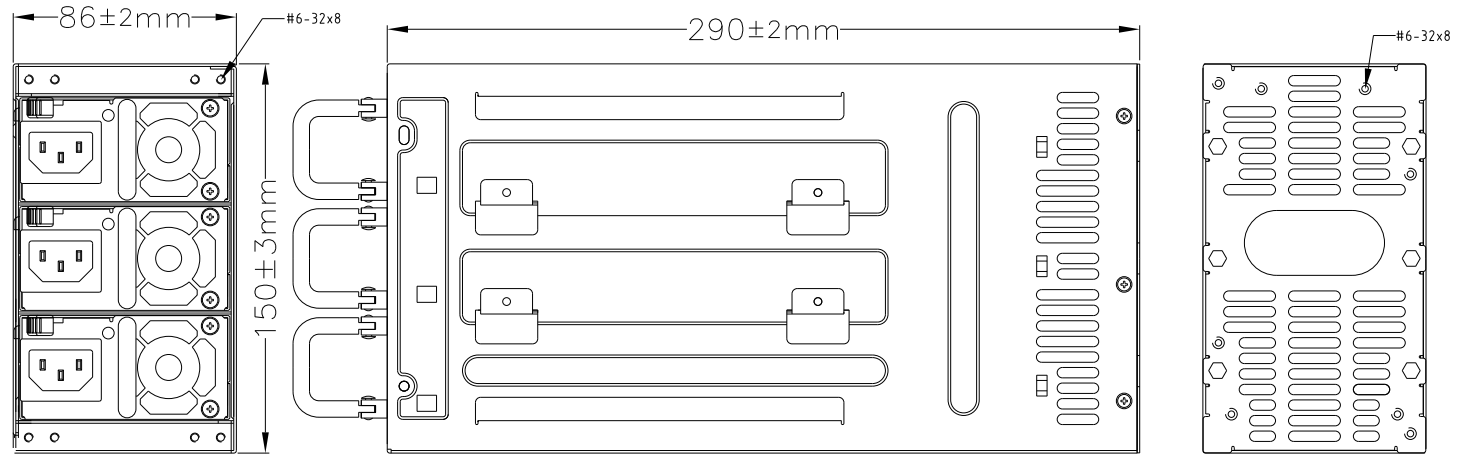
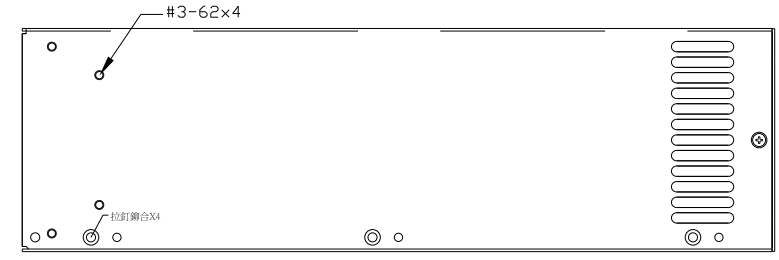
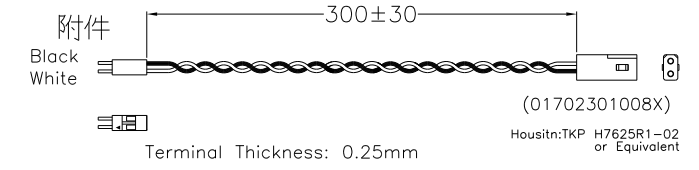

ITEM	PART NO.	DESCRIPTION	QTY
 Thermaltake Technology Co., Ltd			
DRAWING NAME		TP-3UR750L2E_Cable	
PART NO.		WSPR0025_Cable	
DATE	APP.	CHK.	DRAW
2008/07/08			TIN

MATERIAL	
FINISH	
COLOR	
TOLERANCES UNLESS NOTED	REV. T1
0.0 ~ 5	± 0.1
5.0 ~ 20	± 0.2
20.0 ~ 50	± 0.3
50.0 ~ 200	± 0.4
200.0 ~	± 0.5
ANGLE	± 1°